

Wind Screen

Vertical awning with
zip system



saxun[°]
Your world, our universe.

Saxun contributes to the well-being and happiness of people through solutions that improve the spaces in your life. We are in love with spaces and the possibilities they offer us to help us feel good. That's why we develop products that are functional, versatile and comfortable, so that you can make the most of your space in a variety of ways.

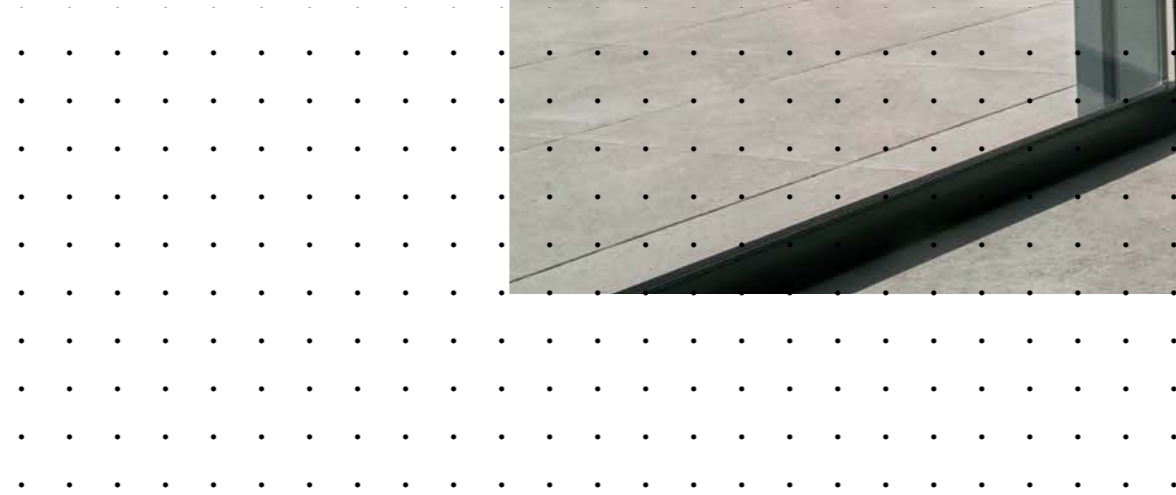



At the service of what matters most

There's nothing like reading a book, having a cup of coffee, watching your favourite show, writing a report or surfing on your computer as you start the evening in the natural light in your favourite corner.

We love the sun and the light it gives us, but we are also passionate about being able to control it.

This is how we introduce the Saxun Wind Screen.

An avant-garde solar protection system specially designed for outdoor installation, which makes it the perfect solution when it comes to managing light and privacy.

Design, functionality and comfort

The Wind Screen generates a textile solar protection developed to provide spaces of well-being, which effectively improve the thermal and visual comfort of the internal environments, while reducing the energy consumption of the property.

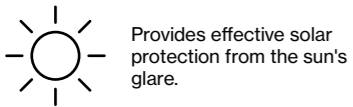

Provides effective solar protection from the sun's glare.



Improves the energy efficiency of the room.



Reduces energy consumption.



Visibility to the outside, protecting privacy.



Generates visual comfort in the interior.



Increases comfort in workspaces.



Fabrics with different degrees of openness.



Retractable system.



Optimum control thanks to its motorisation and automation.



Maximum adaptability, different sizes: 65, 85, 105, 125 and 150.



BIM, CAM product available at saxun.com





High-performance protection

The textile barrier that makes up the Wind Screen offers solar protection that optimises the operating costs of the air conditioning system, adapting the space to the criteria of sustainability and energy efficiency included in the current Technical Building Code.

The geographical orientation of the building is also a determining factor when it comes to choosing the right protection to meet the requirements; the needs of the same building's south façade are not the same as those of its north façade.

However, it is not enough to apply a generic textile. The best alternative available on the market must be chosen for each situation, in order to limit the energy demand of buildings as much as possible.

Thermal and light factors

The different factors to take into account when using a fabric as solar protection, and that will allow controlling temperature, light and privacy in an efficient way, are:

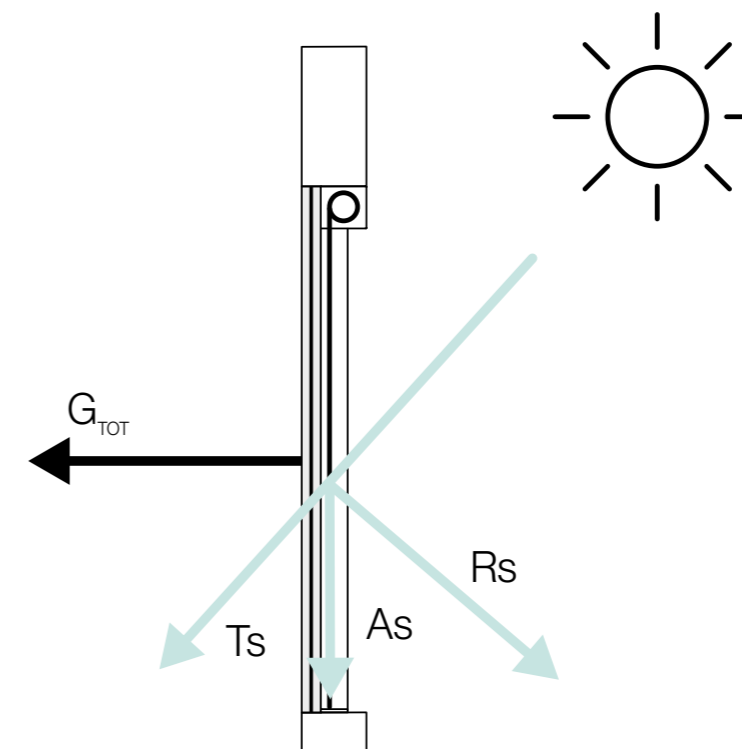

Solar Transmission (ST)

Proportion of solar radiation that passes only through the fabric. A low percentage indicates a good reduction of the solar energy obtained by the fabric.

Solar Reflection (SR)

Proportion of solar radiation reflected by the fabric. A high percentage indicates a good solar reflection of the solar energy obtained by the fabric.

Solar Absorption (SA)

Proportion of solar radiation absorbed by the fabric itself. A low percentage indicates a low absorption of the solar energy obtained by the fabric.

Total Solar Factor (G_{tot})

Percentage of solar energy that actually penetrates into the room through the fabric and glazing, calculated by combining the thermal factors plus the type of glazing. A low value indicates efficient thermal performance.

ST + SR + SA = 100% of energy

Note

Annex A of regulation EN 14501 defines the reference glazing for global comparisons (glazing unknown) of shutters, louvers and awnings. Type C glazing is double glazing (4 mm float + 16 mm chamber + 4 mm float) with low-e coating in position 3 (outer surface of the inner pane), argon-filled chamber (U=1.2 W/m²K and g = 0.59).

Vertical awning with zip system

Wind Screen

In the Wind Screen, the fabric moves vertically via motorisation, and laterally through two self-supporting extruded aluminium guides.

The fabric rolls into an extruded aluminium tube (with different diameters depending on their dimensions), housed inside an accessible aluminium box, enabling the fabric opening to be regulated over its entire run.

When the fabric is stretched, it is perfectly tensioned, guaranteeing optimum shading with elegant precision. When the fabric is collected, it is stored in the cassette and is perfectly protected from dirt and the weather.

This guide is a zip system that guarantees great stability in the face of strong gusts of wind, providing shade over the entire surface it protects and preventing light from entering through the sides.

It integrates an extruded aluminium terminal, which acts as a counterweight and prevents the formation of wrinkles in the fabric, while also hiding its welding.

Allows for finishes in your desired colour, to match the side trim covers and the rest of the components that make up the system.

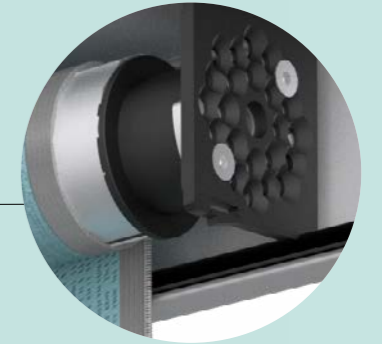
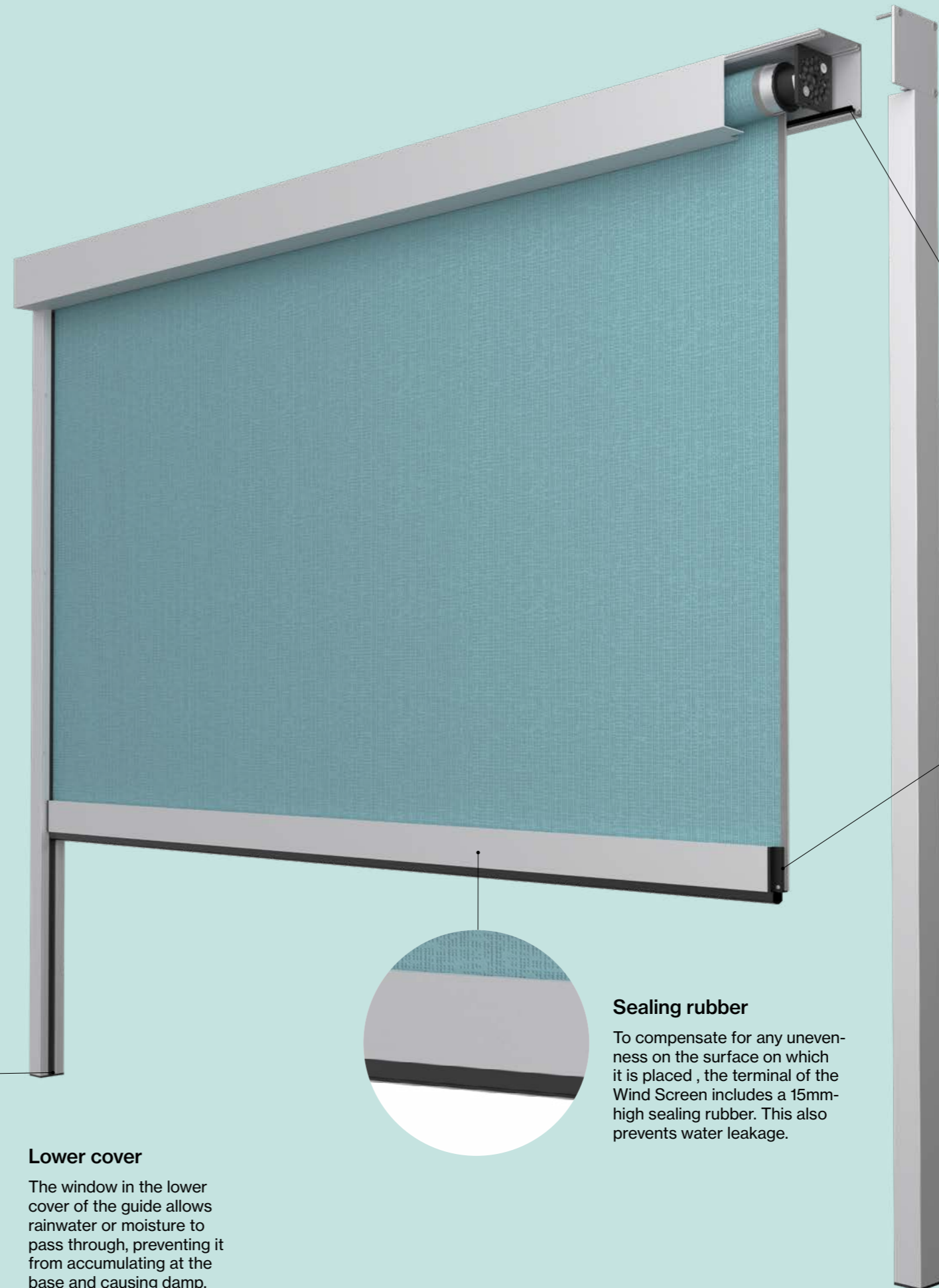

Sealing brush

The cassette within the Wind Screen includes a brush at the back section of the box, to prevent the fabric rubbing against the guide when ascending and descending. This ensures longer fabric life.



Hidden welding

The terminal in these systems is provided in a colour matching the box and guides.

The fabric is inserted into housing inside the terminal that hides the fabric welding from view, making it more aesthetic.

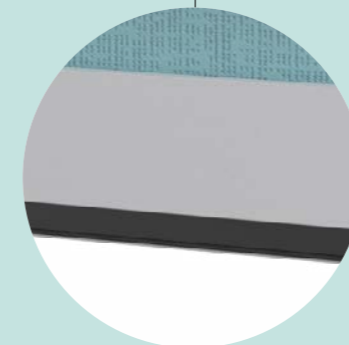

Sealing rubber

To compensate for any unevenness on the surface on which it is placed, the terminal of the Wind Screen includes a 15mm-high sealing rubber. This also prevents water leakage.

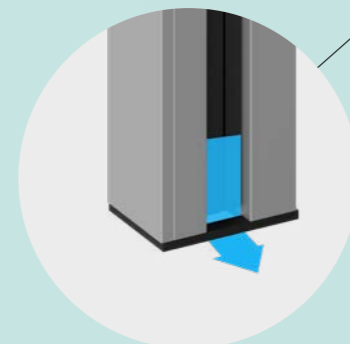

Lower cover

The window in the lower cover of the guide allows rainwater or moisture to pass through, preventing it from accumulating at the base and causing damp.

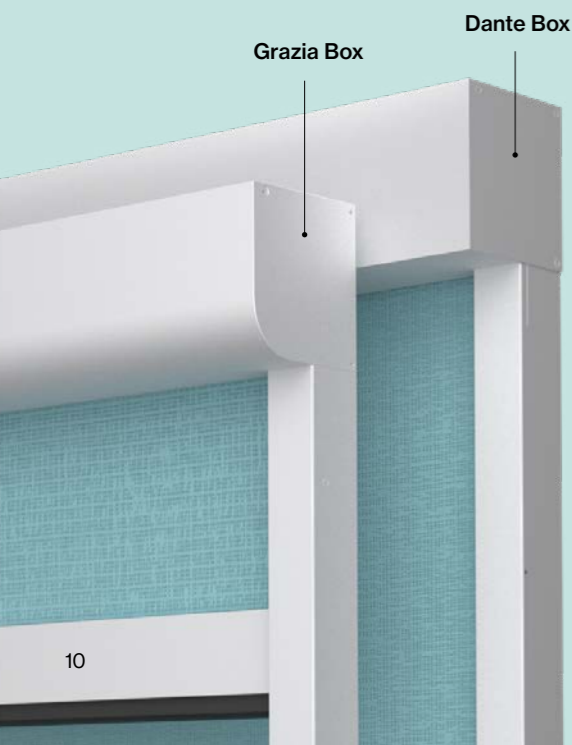

Grazia Box

Dante Box

The widest range of zip system solutions

Models and features

WIND SCREEN	BOX	ACTION	MEASUREMENTS			
			MAXIMUM		MINIMUM	
			HEIGHT ↓↑	WIDTH ↔	HEIGHT ↓↑	WIDTH ↔
WS 65		Motor	*	2.00	-	0.80
		Chain				0.50
WS 85		Motor	*	3.00	-	0.60
		Radius				0.62
WS 105	 	Motor	3.50	4.00	-	0.73
		Radius				0.80
WS 125	 	Motor	3.50	5.00	-	0.75
		Radius				0.79
WS 150		Motor	3.50	6.00	-	0.73
		Radius				0.80

* Depending on the fabric, see winding table in the corresponding data sheet

Resisting the wind

ZIP system

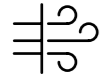

Optimum wind resistance performance.

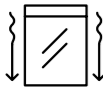

Stable fabric and terminal inside the side guides.

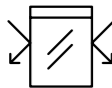

There are no side gaps.

The fabric in the Wind Screen is guided via a ZIP system that allows the integration of the awning into the architecture of any home, providing shade to the entire window opening and preventing light from entering through the side openings of the system, as there are none. In this way, it also prevents insects from entering. Thanks to its zip guidance system, the

fabric stays within the profiles, always providing optimum wind resistance performance.

The zip is welded to the fabric, which makes the fabric and the terminal stable within the side guides, ensuring the system is operational even under the most extreme circumstances.

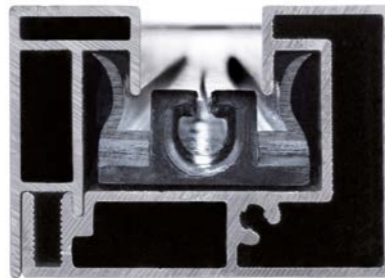

Co-extrusion guide profile

Our zip guide profile is produced via a co-extrusion process, where PVC and rubber are formed at the same time.

With this connection between both components, the noise caused by possible vibrations due to wind action is minimised.

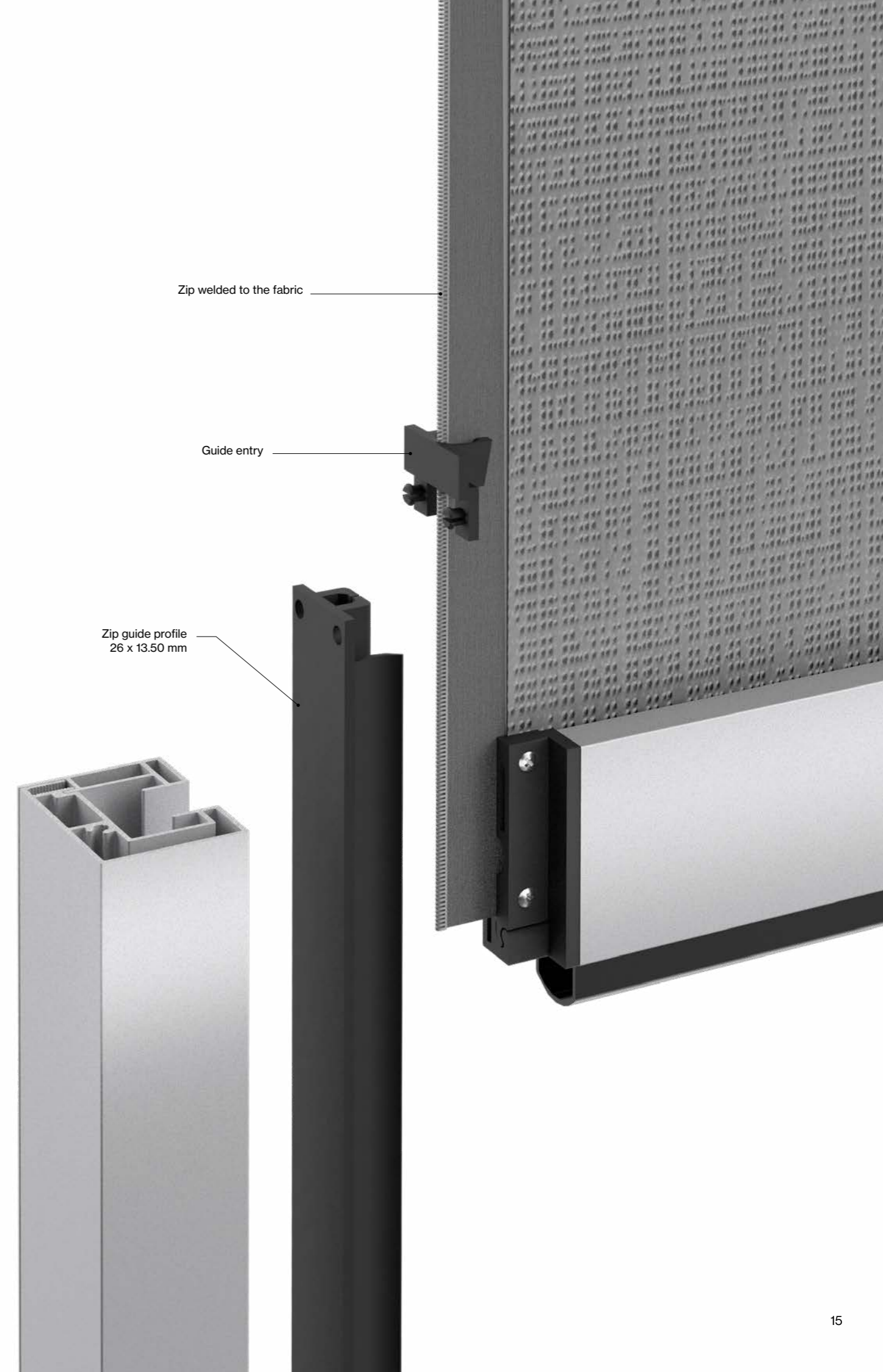

Wind resistance

CLASSES	V-0	V-1	V-2	V-3	V-4	V-5	V-6
Nominal test pressure p (N/m ²)	<50	50	70	100	170	270	400
Safety test pressure 1.5 p (N/m ²)	<75	75	100	150	250	400	600
Nominal speed (km/h)	<33	≈ 33	≈ 38	≈ 46	≈ 60	≈ 76	≈ 92
Safety speed (km/h)	<40	≈ 40	≈ 46	≈ 56	≈ 73	≈ 92	≈ 112

The test carried out in our laboratory produced the result **Class 5 (= 76 km/h)** according to regulation EN 13659:2004+A1:2008.

new

Terminal for Wind Screen 85 and 105

The Wind Screen 85 and 105 models present a new terminal with smaller dimensions, with which we achieve a lighter and more proportionate vision in relation to the size of the box.

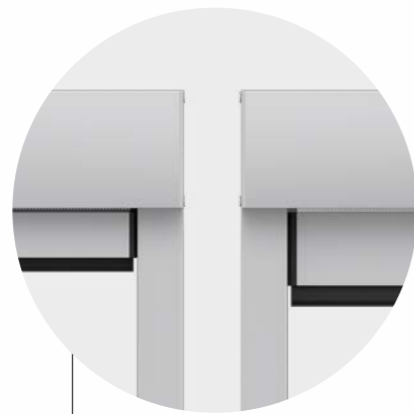

New terminal

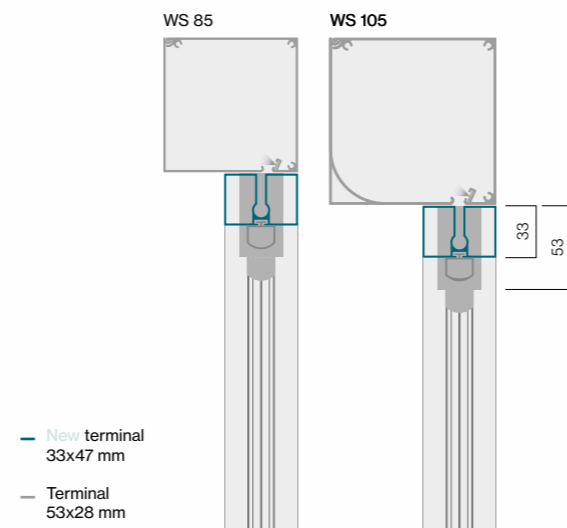

The Wind Screen offers 2 action options:

- Motorisation (230 V).
- Chain (only for 65 system).

End cap plate

Dante and Grazia also present great competitive advantages in their installation process, as the end plate has different holes that provide **multiple possibilities in terms of motorisation or elements to be fixed**.

In this way, it is possible to install the motor in different positions, allowing the exit of the cable or the action of the limit switches, which will considerably facilitate the installer's work.

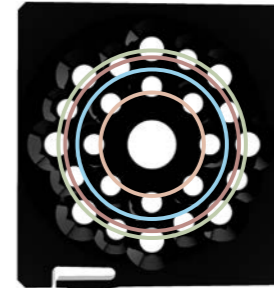

FIXING HOLE DISTANCE

- Ø 29 mm **8 positions**
- Ø 42 mm **4 positions**
- Ø 46 mm **4 positions**
- Ø 48 mm **8 positions**

End cap plate

Examples of end cap plate compatibility with different types of motorisation:

Motor-driven installation with RH head



Motor-driven installation with normal head



new

Axle cups in Wind Screen 125 and 150

The new axle cups for these two models allow for faster factory assembly, reducing manufacturing and service times.

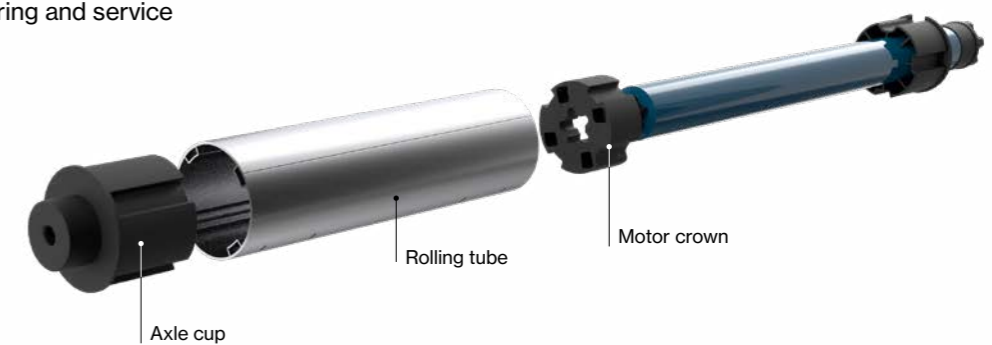

Sections and profiles



Sections

WS 65
Grazia

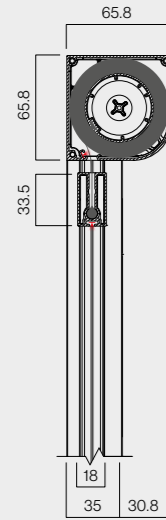

WS 85
Dante

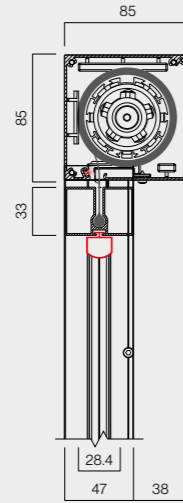

WS 105
Dante&Grazia

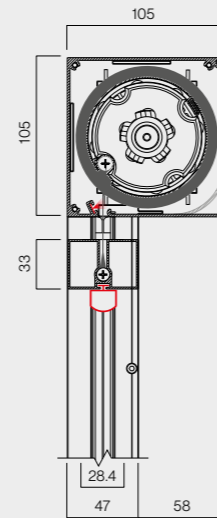

WS 125
Dante&Grazia

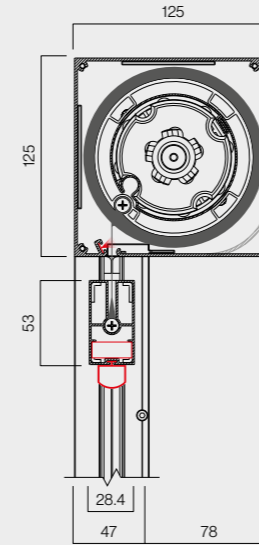

WS 150
Dante

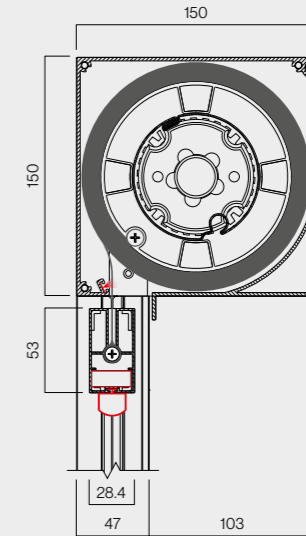

Profiles

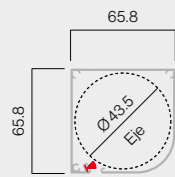

Box profile 65
100153

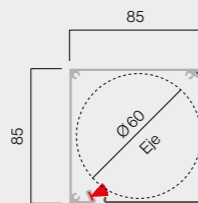

Box profile 85
024626
Box profile 85
024625

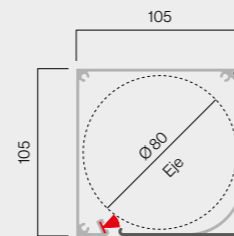

Box profile 105
Dante&Grazia
024122
Box profile 105
Dante
024124
Box profile 105
Grazia
024123

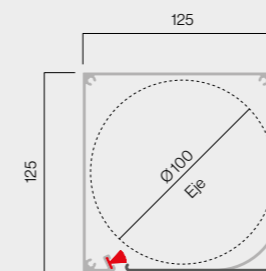

Box profile 125
Dante&Grazia
024128
Box profile 125
Dante
024129
Box profile 125
Grazia
024130

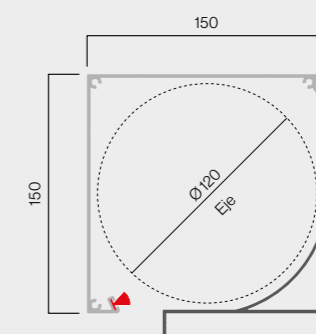

Box profile 150
024465
Box profile 150
024463

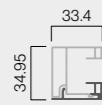

Clippable Premium
lower guide
100152
Clippable Premium
upper guide
100151

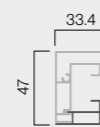

Lower guide 33.4 mm
024125
Upper guide
024126



Lower guide 33.4 mm
024125
Upper guide
024126

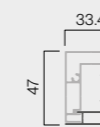

Lower guide 33.4 mm
024125
Upper guide
024126

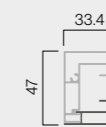

Lower guide 33.4 mm
024125
Upper guide
024126



Terminal 33.5x18 mm
100150

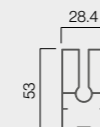

Terminal 53x28 mm
024131

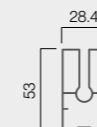

Terminal 53x28 mm
024131

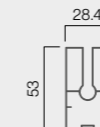

Terminal 53x28 mm
024131

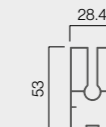

Terminal 53x28 mm
024131

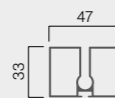

Terminal 33x47 mm
024947

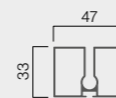

Terminal 33x47 mm
024947



Zip guide profile
26x13.5 mm
024179



Zip guide profile
26x13.5 mm
024179



Zip guide profile
26x13.5 mm
024179



Zip guide profile
26x13.5 mm
024179



Zip guide profile
26x13.5 mm
024179

A flexible solution

Installation inside the window opening:

Motor

Chain (only WS Grazia 65)



Installation in Saxun Bioclimatic Pergolas:

Bioclimatic Pergola P-190



Installation on façade:

Motor



Bioclimatic Pergola P-150

Fabrics

A world full of inspiration

The fabrics used in our Wind Screen guarantee outstanding strength, durability and performance. They provide excellent protection against UV radiation, are resistant to high temperatures and to the action of water, and remain dimensionally stable.

An extensive collection of finishes, with the guarantee of the best suppliers, offering the latest trends in design with the assurance that they will respond with optimum performance.



ACRYLICS

The daily needs of each consumer require various different solutions adapted to each of our products. That is why our range of colours, designs and textures, designed to guarantee maximum comfort, are adapted to the needs of architects and interior designers all over the world.

The mass pigmenting system ensures that the colour of the product remains intact despite the passage of time and its use outdoors.

SCREEN

Our Sax Screen range or the new Screen Titan and Screen 2165 (in different opening factors) are highly used due to their role as a thermal protector and as a screen that guarantees excellent visibility to the outside.

When it comes to total blackout, you can choose from a variety of options from our Black-Out series, such as the Screen Elarus Black-Out.

SOLTIS

Soltis is a range of composite fabrics created for indoor and outdoor use. High-performance technical fabrics; perforated, waterproof and even opaque. They provide visibility to the outside, protection against heat or total privacy, depending on the needs of each space or user.

PVC

The most useful property of PVC fabrics is that they are fully waterproof, so are able to withstand intense wind and rain. They are particularly effective in wet environments, helping to make sure that indoor spaces are always kept dry.

Prescription and projects

The best resource for designers

These innovative systems increase the aesthetic value of façades, whether in domestic, commercial, hotel, industrial or institutional applications.

Also, the textile advances that have greatly increased the quality of the fabrics in terms of their performance outdoors allow architects and designers to include our Wind Screen in all types of projects.

We live in an era in which glass is more present than ever. Large windows are essential in the most avant-garde homes

in order to achieve an integration of the interior space with the exterior, and thus obtain greater comfort and well-being.

A very current trend, but which at the same time coexists with the latest legislation on thermal regulation of buildings.

For this reason, our Wind Screen systems, thanks to their ability to filter light and protect rooms that receive the sun's rays, have become a must-have for the most demanding decorators.

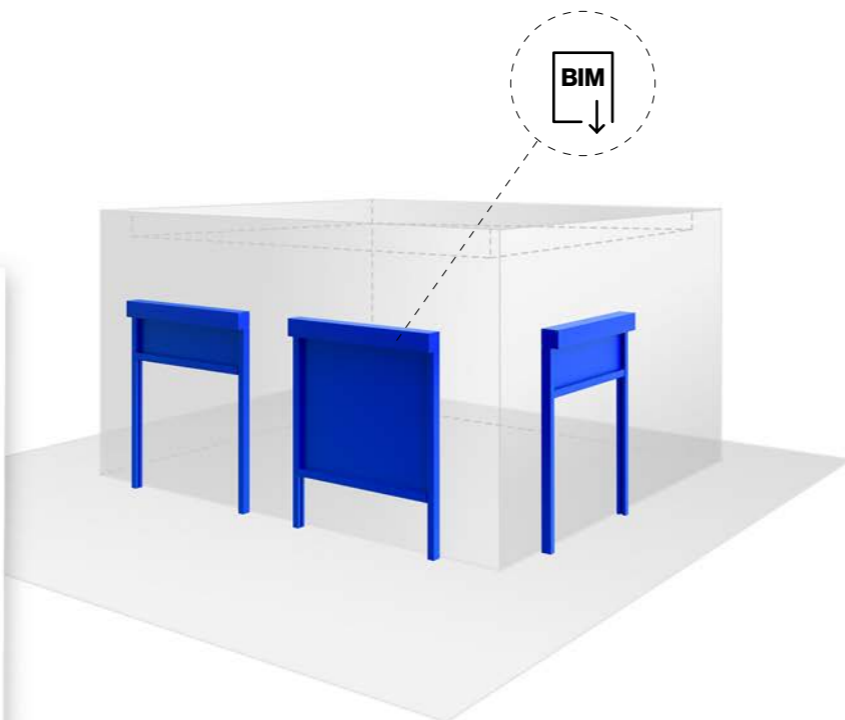

Data sheet.



Your world, made easier



Comfort, tranquility (and security), energy control and flexibility are attributes that, nowadays, we ask of all the spaces in our lives.

To achieve this, technology offers us the option to motorise, automate and connect lighting, temperature, household appliances and solar protection systems or enclosures. Whether at home or at work. Thus, we obtain intelligent spaces.

Saxun gives you a variety of action options and intelligent solutions to control your shutters, awnings and curtains in the most comfortable and efficient way. In particular, Wind Screen is a motorised system that can be automated.



Controls and Automations

By pressing the button on your transmitter, you can control the light input, glare or your privacy as you wish. Our controls offer a modern and refined design that blends perfectly into any space. They allow you to configure the operation of one or more elements, in the usage scenarios you want.

Sun, wind and rain sensors will take care of controlling the operation of your system in the event of any weather change, without the need for you to keep an eye on it. The Wind Screen will automatically lower when the sun is shining, and retract in case of wind or rain.



Smart Home

Home automation isn't seen; it's enjoyed. Via WiFi, you can take control of all the electronic devices in your home. And that includes being able to control all of our solutions.

The Wind Screen will automatically go up when the day begins, and you can create all the routines you can imagine from your smartphone or tablet, and from anywhere. Thanks to an application based on io technology, programming your home to use energy more efficiently will also help you live more comfortably.

Colours and finishes

Our universe of colours...

A product like the Wind Screen would not achieve excellence if it weren't for the top finishes we offer. In addition to the high-performance technical fabrics, this system is made of extruded aluminium profiles of the highest quality.

The finish of the profiles must perfectly match the colour of the tarpaulin. This is why they are available in any colour on

the RAL chart, textured finishes, special lacquers (mottled, metallic, anodic), wood imitation lacquers, anodised and foliated finishes, as well as specific charts for architects, always subject to the most demanding European standards in order to guarantee excellent performance in all types of conditions.



Our state-of-the-art lacquering process is based on Qualicoat prescriptions (international quality seal for lacquered aluminium that guarantees its quality for use in architecture) and allows a wide variety of processes and high-performance finishes that adapt to every requirement:

- General multi-metal process (not Qualicoat).
- Equivalent to standard Qualicoat.
- For installations exposed to the sea, we can offer a superior quality of Qualicoat, which is the Seaside Class. Within this classification, the AA1 fully coincides with the Qualimarine seal, awarded by the French Association (ADAL).

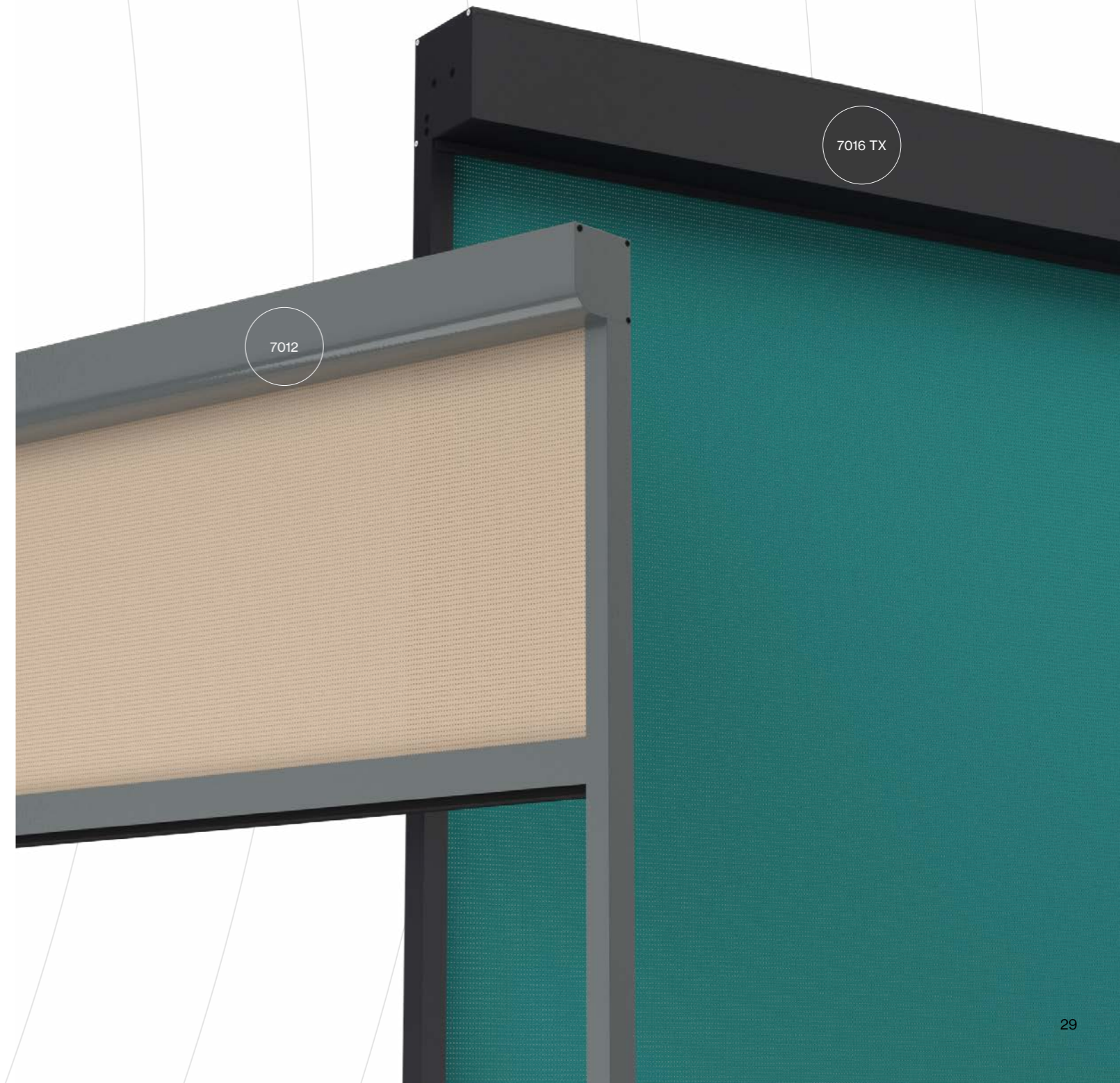

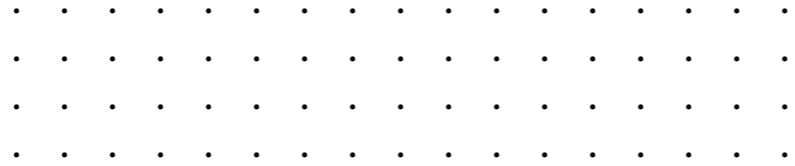

Saxun offers you the widest range of enclosure, solar protection and decoration solutions on the market to improve your living spaces; adapting to your needs and style, so that you can feel safe and at ease.

saxun[®]
by Giménez Ganga

Giménez Ganga, S.L.U.
Polígono Industrial El Castillo
C/ Roma, 4
03630 • Sax (Alicante) • Spain

saxun.com

Your world,
our universe.

